



2019 BOTTLE RANGE



CHANDLER GLASS & PACKAGING

T: +64 9 448 1288 · E: info@chandler.co
PO Box 303-237, North Harbour,
Auckland 0751, New Zealand.
www.chandler.co

CHANDLER GLASS & PACKAGING

Chandler Glass & Packaging (Chandler) was established in 2007 to provide an alternative, reliable source of wine bottles, as well as a greater range of options. We coordinate, quality control and supply wine bottles to wine producers in the New Zealand, United States and Australia. Along with this, our aim is to provide great service and competitive pricing to New Zealand winemakers, without compromising bottle performance or visual quality.

Currently, Chandler annually coordinates the production and supply of 100+ million wine bottles for wineries within these markets and is the largest alternative supplier of wine bottles to New Zealand.

We have developed and own a proven & reliable range of BVS mouth bottles, sparkling and cork mouth bottle moulds— of varying weights and shapes. We set out to lift the consistency of wine bottle quality within the markets that we operate — especially around the controls for the BVS mouth finish and label panels. In doing so, we have encouraged improvement to the general standard of wine bottles within these markets and elevated the quality expectations of our clients.

WHAT CHANDLER DOES

Our team of on-line quality control personnel operate 24 hours, 7 days a week, monitoring output on every production line at our manufacturer's facilities. We measure and inspect our production against well-established quality control points before the bottles are packed, eliminating the non-conformance risks commonly associated with imported glass.

Meanwhile, our experienced domestic-based team work closely with you to make sure your company receives its required products in full, at competitive prices, as and when required.

PALLET CONFIGURATION

Bottles are packed on international sized one-way plywood pallets (1.0 x 1.2m) with a light plywood top frame. Bottles are usually supplied as a 7 layer configuration. However bottles that are greater than 318mm in height are stowed as 6 layers.



WHAT ELSE DOES CHANDLER GLASS & PACKAGING OFFER?

Whilst we focus on delivering a competitively priced standard range of mid to heavy weight Premium BVS bottles, our other capabilities lie in the production and delivery of:-

- Premium and Super Premium (heavy) cork mouth bottles
- Bottles no longer readily available — including many cork mouth models phased out by other bottle producers
- Permanent decorations applied at source — screen printed and decal
- Embossing & Debossing logos
- Bespoke bottle shapes and design

New bottle designs, customised emboss/deboss logos or decorated bottles — order requirements are delivered via a disciplined and deliberate design and sign-off approval process, which includes:-

- Final technical drawings and packaging specifications
- Quality control parameters and tolerances (dual language)
- Pre-production sampling (for all new bottles or decoration designs)

BESPOKE WINE BOTTLES



*

PROPRIETARY OR
SPECIAL SURFACE



BESPOKE FORM + SIDE
DEBOSS BELT WITH
EMBOSS TEXT



SHOULDER EMBOSS TO
STANDARD FORM



HEEL DEBOSS BELT +
EMBOSS TEXT

WINE BOTTLE DECORATIONS



*

MULTI-COLOUR
SCREEN PRINT



SCREEN PRINT WRAP +
HOT-FOIL STAMP



SCREEN PRINT +
HOT-FOIL STAMP



*

HOT TRANSFER FOIL
& MULTI-COLOUR
DECORATION

BURGUNDY BVS RANGE



Burgundy
Legere



Burgundy
Legere



Burgundy
Legere

CR404



Burgundy
Export



Burgundy
Export

CR403



Burgundy
Premier

CR408



Burgundy
Traditional

CR403



Burgundy
Avignon

CR401



Burgundy
Avignon



Burgundy
Sextant

CR409



Burgundy
Passion

CR407

BURGUNDY CORK RANGE



Burgundy
Alba

CR40028



Burgundy
Prestige Magnum

CR4021



Burgundy
Magnum Prestige



Burgundy
Luca

CR418



Burgundy
Traditional C

CR416



Burgundy
Dali

CR427



Burgundy
Lola

CR419



Burgundy
Mercure

CR446

FLUTE RANGE



Flute Primo

CR302



Flute Primo



Sparkling
Carbeco

CR987



Sparkling
Beaumont

CR958



Sparkling
Gallivant

CR989



Sparkling
Brut

CR983

BORDEAUX BVS RANGE



Bordeaux
Svelte



Bordeaux
Svelte



Bordeaux
Svelte

CR501



Bordeaux
Premium Export



Bordeaux
Premium Export

CR507



Bordeaux
Transition



Bordeaux
Transition

CR504



Bordeaux
Superior

CR5105



Bordeaux
Premium

CR508



Bordeaux
Premium



Bordeaux
Vimone

CR506

BORDEAUX CORK RANGE



Bordeaux
Elite

CR509



Bordeaux
Resolute



Bordeaux
Resolute

CR5011



Bordeaux
Traditional C

CR516



Bordeaux
Futura

CR5125



Bordeaux
Medoc

CR518



Bordeaux
Stratus

CR527



Bordeaux
Elite C

CR519



Bordeaux
Emperor

CR529



Bordeaux
Repent

CR5312

WINE BOTTLE RANGE: BOTTLING SEASON 2019



ANTIQUÉ (ANT)

FRENCH GREEN (FG)

FLINT (FLT)

AVAILABLE	CODE	DESCRIPTION	VOL ml	COLOUR(S)	MOUTH	WEIGHT	HEIGHT	DIAMETER	PLT LOAD
BURGUNDY BVS									
Std ANT, FG, FLT	CR404	BURGUNDY LEGERE	750	ANT, FLT, FG	BVS 30 x 60	420g	297mm	80mm	1,407
Std ANT, FG	CR403	BURGUNDY EXPORT	750	ANT, FG	BVS 30 x 60	480g	298mm	80mm	1,407
Std ANT	CR408	BURGUNDY PREMIER	750	ANT	BVS 30 x 60	555g	296mm	85.8mm	1,225
MTO	CR401	BURGUNDY TRADITIONAL	750	ANT, FG	BVS 30 x 60	555g	298mm	81.5mm	1,358
Std FLT	CR4015	BURGUNDY AVIGNON	750	ANT, FLT	BVS 30 x 60	590g	300mm	87.4 / 80.8mm	1,183
MTO	CR409	BURGUNDY SEXTANT	750	ANT	BVS 30 x 60	615g	295mm	86.2mm	1,225
Std ANT	CR407	BURGUNDY PASSION	750	ANT	BVS 30 x 60	800g	299mm	88mm	1,183
MTO	CR40028	BURGUNDY ALBA	750	ANT	BVS 31.5 x 60	820g	306mm	86.2mm	1,183
Std ANT, FLT	CR4021	BURGUNDY PRESTIGE MAGNUM*	1500	ANT, FLT	BVS 30 x 60	880g	345mm	106mm	315
BORDEAUX BVS									
Std ANT, FG	CR501	BORDEAUX SVELTE	750	ANT, FLT, FG	BVS 30 x 60	415g	295mm	75.2mm	1,624
Std ANT, FLT	CR507	BORDEAUX PREMIUM EXPORT	750	ANT, FLT	BVS 30 x 60	510g	310mm	75.4mm	1,624
MTO	CR504	BORDEAUX TRANSITION	750	ANT, FLT	BVS 30 x 60	540g	300mm	76.3mm	1,575
MTO	CR5015	BORDEAUX SUPERIOR*	1000	ANT, FLT	BVS 30 x 60	550g	317mm	84.5mm	1,225
Std ANT	CR508	BORDEAUX PREMIUM	750	ANT, FLT	BVS 30 x 60	580g	310mm	76.2mm	1,561
MTO	CR506	BORDEAUX VIMONE	750	ANT	BVS 30 x 60	670g	304mm	82.3 / 75mm	1,288
Std ANT	CR509	BORDEAUX ELITE*	750	ANT	BVS 30 x 60	695g	329mm	77.6 / 72mm	1,350
ANT, FLT	CR5011	BORDEAUX RESOLUTE*	750	ANT, FLT	BVS 30 x 60	695g	329mm	75mm	1,392
HOCK / FLUTE BVS									
Std ANT, FLT	CR302	FLUTE PRIMO*	750	ANT, FLT	BVS 30 x 60	320g	329mm	75.3mm	1,392

SEE CORK RANGE ON NEXT PAGE.

Std = batch produced – standard range
 MTO = made to order. These bottles are not normally held as inventory at the factory but please enquire. Stock is only produced if combined client orders reach the MOQ of 300,000 bottles. When reached, the delivery lead-time for this category of bottle is an additional 8 weeks to the standard range.

Pallet Configuration

All pallets are 7 layers unless indicated with '*'. These pallets are 6 layers.
 Bottles are supplied on one-way international sized pallets (1.0 x 1.2m).

Please enquire to find out more. info@chandler.co

WINE BOTTLE RANGE: BOTTLING SEASON 2019



AVAILABLE	CODE	DESCRIPTION	VOL ml	COLOUR(S)	MOUTH	WEIGHT	HEIGHT	DIAMETER	PLT LOAD
SPARKLING									
MTO	CR982	SPARKLING CARBECO	750	ANT	Champagne cork	680g	299mm	84.6mm	1,225
Std ANT	CR988	SPARKLING BEAUMONT	750	ANT	Champagne cork	795g	300mm	86.5mm	1,169
Std ANT	CR989	SPARKLING GALLIVANT	750	ANT	Champagne cork	800g	304mm	85.5mm	1,229
Std ANT	CR983	SPARKLING BRUT	750	ANT	Champagne cork	880g	279mm	95.5mm	994
BURGUNDY CORK MOUTH									
MTO	CR418	BURGUNDY LUCA V	750	ANT	CORK 29	512g	295mm	84.7mm	1,229
MTO	CR416	BURGUNDY TRADITIONAL C	750	ANT	CORK 29	525g	296mm	81mm	1,372
MTO	CR427	BURGUNDY DALI	750	ANT	CORK CAREÉ 31.5	600g	296mm	82.4mm	1,372
MTO	CR419	BURGUNDY LOLA	750	ANT	CORK 29	640g	295mm	88mm	1,169
MTO	CR446	BURGUNDY MERCURE	750	ANT	CORK CAREÉ 33	870g	305mm	88.2mm	1,176
BORDEAUX CORK MOUTH									
MTO	CR516	BORDEAUX TRADITIONAL C	750	ANT	CORK 29	540g	301.6mm	76.5mm	1,575
MTO	CR5125	BORDEAUX FUTURA	1000	ANT, FLT	CORK 29	595g	325mm	83.7mm	1,080
MTO	CR518	BORDEAUX MEDOC	750	ANT	CORK 29	665g	306.5mm	82.5 / 74.5mm	1,372
MTO	CR527	BORDEAUX STRATUS	750	ANT	CORK CAREÉ 31.5	695g	310mm	77.3mm	1,491
MTO	CR519	BORDEAUX ELITE C*	750	ANT	CORK 29	695g	329.5mm	77.9 / 71.9mm	1,350
MTO	CR529	BORDEAUX EMPEROR	750	ANT	CORK CAREÉ 31.5	990g	312mm	86.3 / 77.6mm	1,054
MTO	CR5312	BORDEAUX REPENT*	750	ANT	CORK CAREÉ 32	1200g	325mm	87.6 / 80.3mm	858

There are as many as 15 additional Cork mouth bottles available.

Std = batch produced – standard range
 MTO = made to order. These bottles are not normally held as inventory at the factory but please enquire. Stock is only produced if combined client orders reach the MOQ of 300,000 bottles. When reached, the delivery lead-time for this category of bottle is an additional 8 weeks to the standard range.

Pallet Configuration

All pallets are 7 layers unless indicated with '*'. These pallets are 6 layers.
 Bottles are supplied on one-way international sized pallets (1.0 x 1.2m).

Please enquire to find out more. info@chandler.co

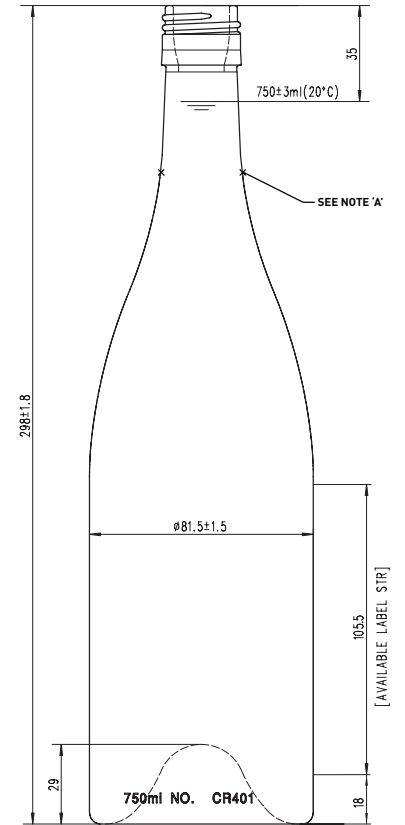
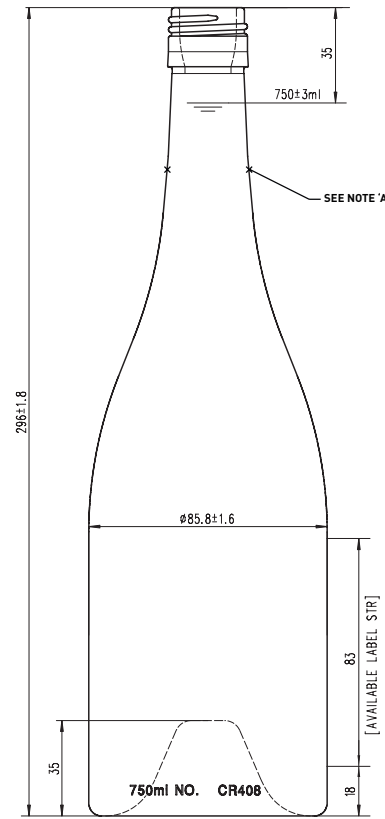
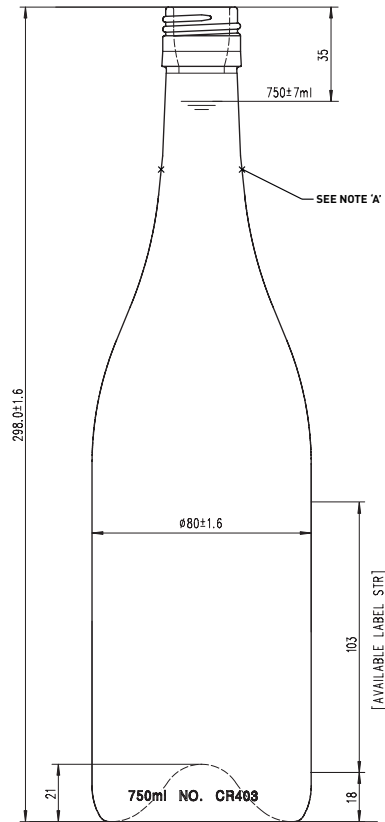
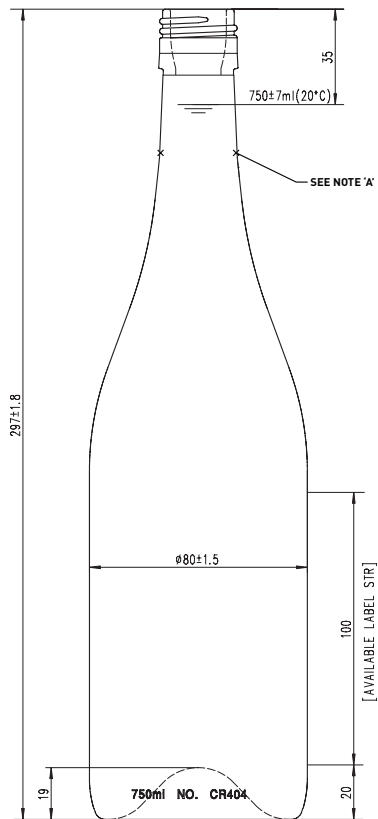

Burgundy LEGERE

Product Code:	CR404
Mouth Finish:	BVS 30 x 60
Diameter:	80mm ± 1.5mm
Height:	297mm ± 1.8mm
Label Panel:	100mm
Punt Depth:	19mm
Weight:	420g
75cl Fill Point:	35mm
Pallet Load:	1,407
Layers:	7

Burgundy EXPORT

Product Code:	CR403
Mouth Finish:	BVS 30 x 60
Diameter:	80mm ± 1.6mm
Height:	298mm ± 1.6mm
Label Panel:	103mm
Punt Depth:	21mm
Weight:	480g
75cl Fill Point:	35mm
Pallet Load:	1,407
Layers:	7

Burgundy PREMIER

Product Code:	CR408
Mouth Finish:	BVS 30 x 60
Diameter:	85.8mm ± 1.6mm
Height:	296mm ± 1.8mm
Label Panel:	83mm
Punt Depth:	35mm
Weight:	555g
75cl Fill Point:	35mm
Pallet Load:	1,225
Layers:	7

Burgundy TRADITIONAL

Product Code:	CR401
Mouth Finish:	BVS 30 x 60
Diameter:	81.5mm ± 1.5mm
Height:	298mm ± 1.8mm
Label Panel:	105.5mm
Punt Depth:	29mm
Weight:	555g
75cl Fill Point:	35mm
Pallet Load:	1,358
Layers:	7

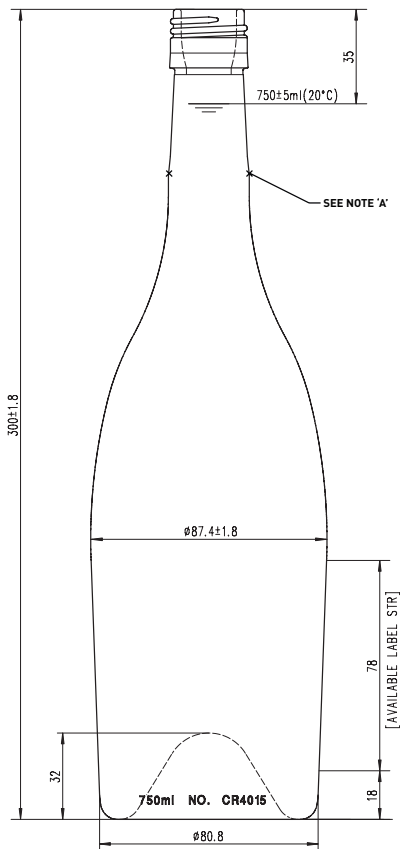

Burgundy AVIGNON	
Product Code:	CR4015
Mouth Finish:	BVS 30 x 60
Diameter:	87.4 / 80.8mm
Height:	300mm ± 1.8mm
Label Panel:	78mm
Punt Depth:	32mm
Weight:	590g
75cl Fill Point:	35mm
Pallet Load:	1,183
Layers:	7

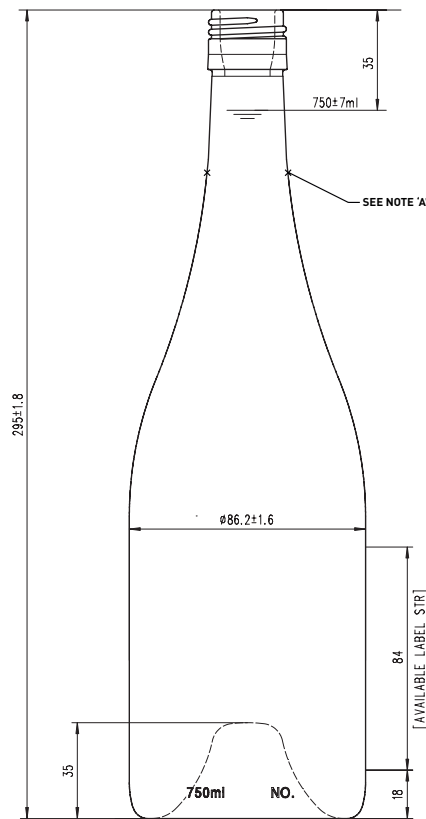

Burgundy SEXTANT	
Product Code:	CR409
Mouth Finish:	BVS 30 x 60
Diameter:	86.2mm ± 1.6mm
Height:	295mm ± 1.8mm
Label Panel:	84mm
Punt Depth:	35mm
Weight:	615g
75cl Fill Point:	35mm
Pallet Load:	1,225
Layers:	7

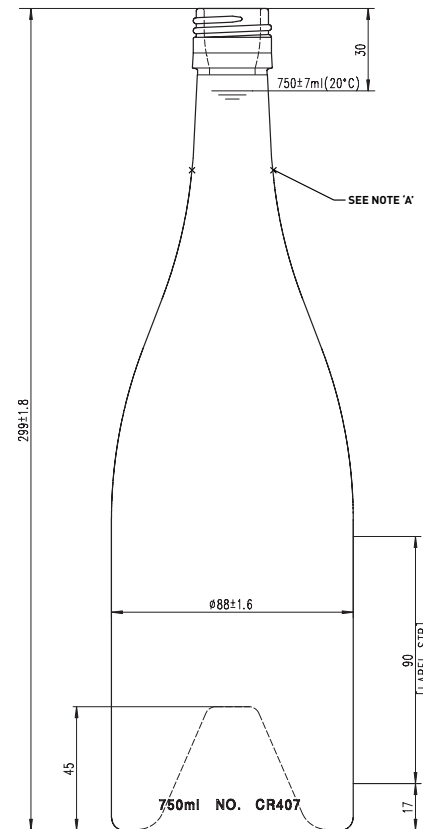

Burgundy PASSION	
Product Code:	CR407
Mouth Finish:	BVS 30 x 60
Diameter:	88.0mm ± 1.6mm
Height:	299mm ± 1.8mm
Label Panel:	90mm
Punt Depth:	45mm
Weight:	800g
75cl Fill Point:	30mm
Pallet Load:	1,183
Layers:	7

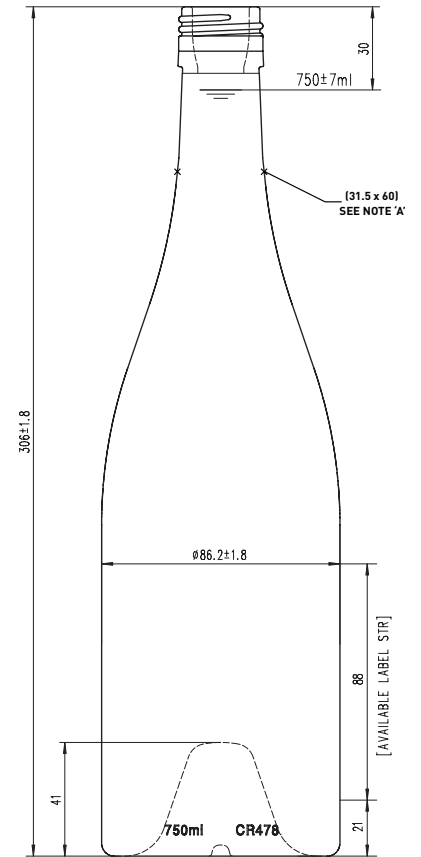

Burgundy ALBA	
Product Code:	CR40028
Mouth Finish:	BVS 31.5 x 60
Diameter:	86.2mm ± 1.8mm
Height:	306mm ± 1.8mm
Label Panel:	88mm (Ø4.5mm heel)
Punt Depth:	41mm
Weight:	820g
150cl Fill Point:	30mm
Pallet Load:	1,183
Layers:	7

75cl BURGUNDY³

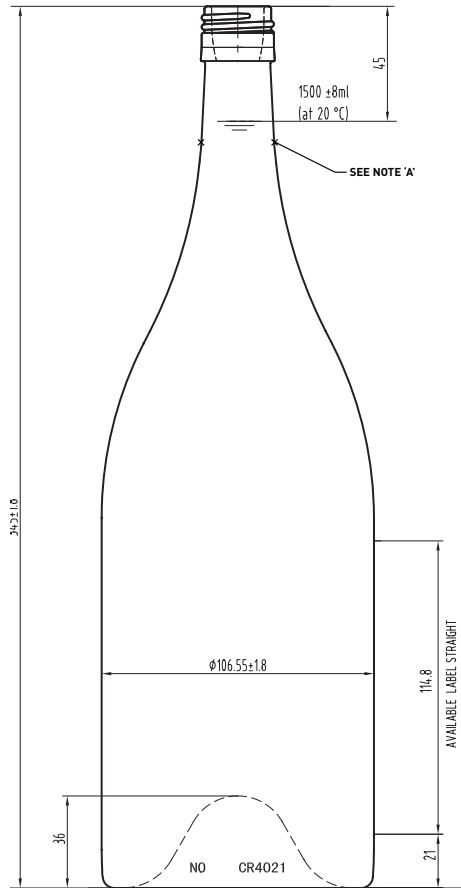

Burgundy PRESTIGE (Magnum)

Product Code:	CR4021
Mouth Finish:	BVS 30 x 60
Diameter:	106.55mm ± 1.8mm
Height:	345mm ± 1.8mm
Label Panel:	114.8mm
Punt Depth:	36mm
Weight:	880g ± 30g
150cl Fill Point:	45mm
Pallet Load:	315
Layers:	3

75cl BORDEAUX¹

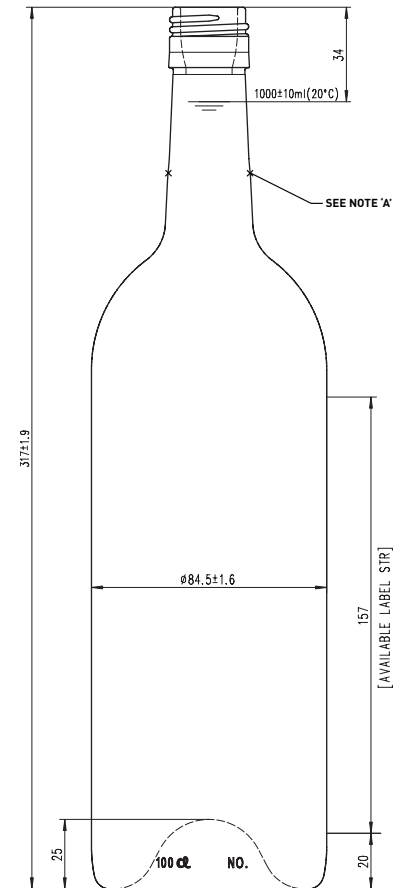
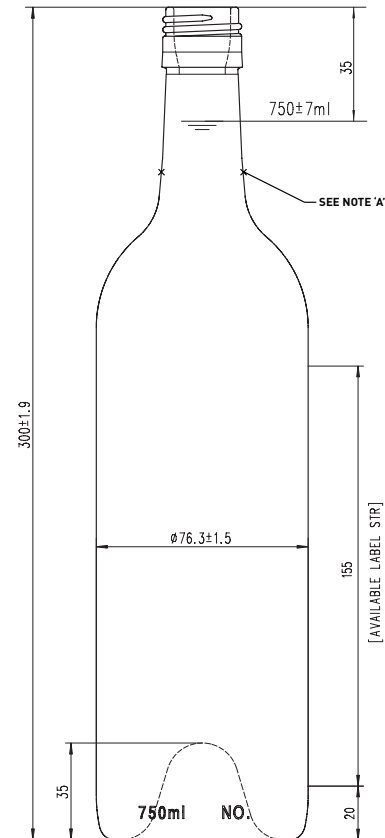
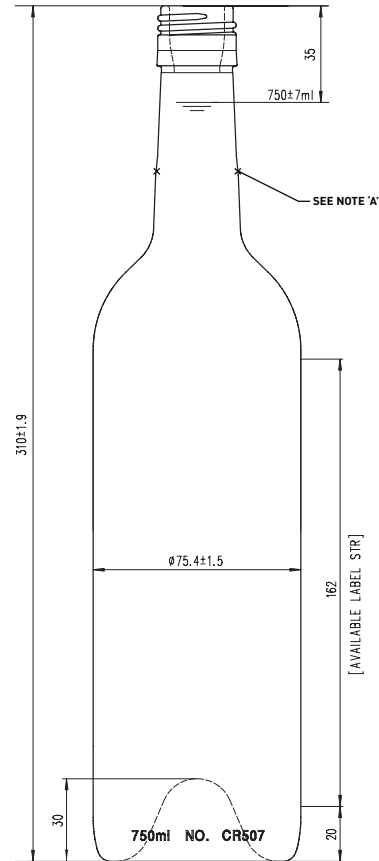
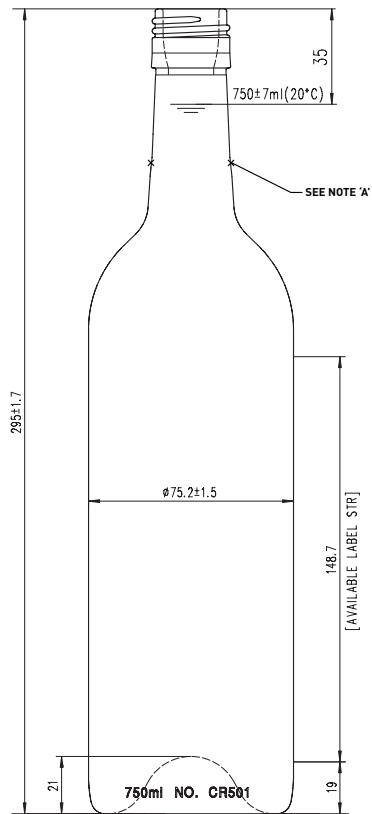

Bordeaux SVELTE

Product Code:	CR501
Mouth Finish:	BVS 30 x 60
Diameter:	75.2mm ± 1.5mm
Height:	295mm ± 1.7mm
Label Panel:	148.7mm
Punt Depth:	21mm
Weight:	415g
75cl Fill Point:	35mm
Pallet Load:	1,624
Layers:	7

Bordeaux PREMIUM EXPORT

Product Code:	CR507
Mouth Finish:	BVS 30 x 60
Diameter:	75.4mm ± 1.5mm
Height:	310mm ± 1.9mm
Label Panel:	162mm
Punt Depth:	30mm
Weight:	510g
75cl Fill Point:	35mm
Pallet Load:	1,624
Layers:	7

Bordeaux TRANSITION

Product Code:	CR504
Mouth Finish:	BVS 30 x 60
Diameter:	76.3mm ± 1.5mm
Height:	300mm ± 1.9mm
Label Panel:	155mm
Punt Depth:	35mm
Weight:	540g
75cl Fill Point:	35mm
Pallet Load:	1,575
Layers:	7

Bordeaux SUPERIOR (1 Litre)

Product Code:	CR5015
Mouth Finish:	BVS 30 x 60
Diameter:	84.5mm ± 1.6mm
Height:	317mm ± 1.9mm
Label Panel:	157mm
Punt Depth:	25mm
Weight:	550g
100cl Fill Point:	34mm
Pallet Load:	1,225
Layers:	7

NOTE A: CONTROLLED NECK & MOUTH REFER TO: DIMENSIONAL SPECIFICATIONS FOR BVS GLASS MOUTH FINISH – Norm: EN16293

75cl BORDEAUX²

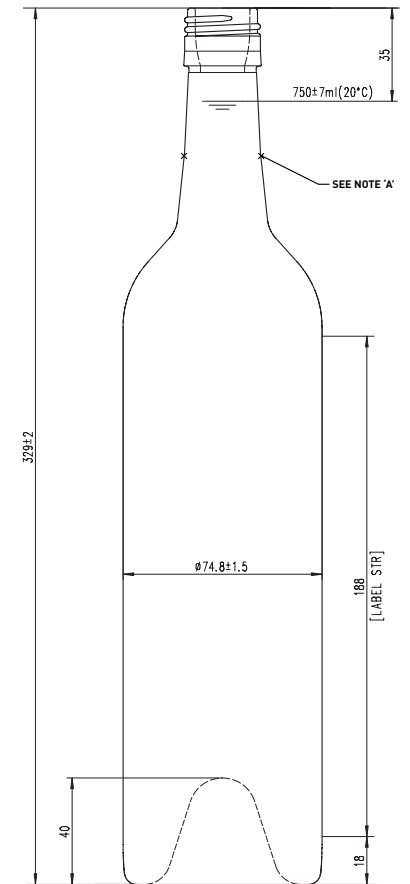
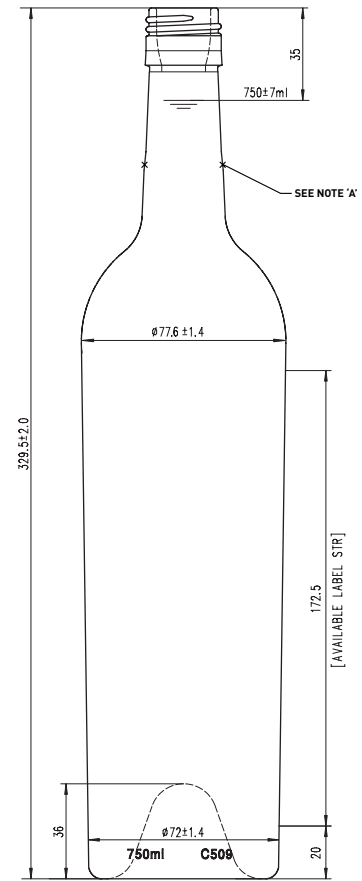
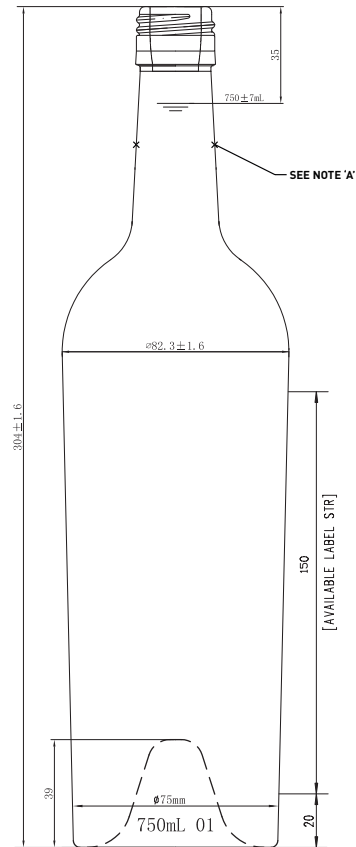
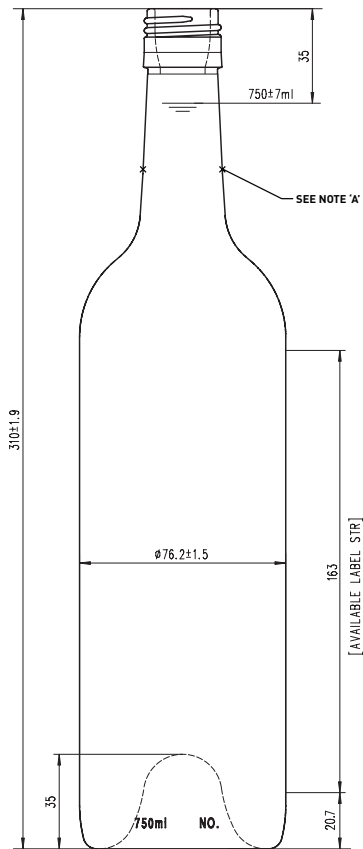

Bordeaux PREMIUM

Product Code:	CR508
Mouth Finish:	BVS 30 x 60
Diameter:	76.2mm ± 1.5mm
Height:	310mm ± 1.9mm
Label Panel:	163mm
Punt Depth:	35mm
Weight:	580g
75cl Fill Point:	35mm
Pallet Load:	1,561
Layers:	7

Bordeaux VIMONE (Tapered)

Product Code:	CR506
Mouth Finish:	BVS 30 x 60
Diameter:	Shoulder 82.3mm / Base 75mm
Height:	304mm ± 1.6mm
Label Panel:	150mm
Punt Depth:	39mm
Weight:	670g
75cl Fill Point:	35mm
Pallet Load:	1,228
Layers:	7

Bordeaux ELITE (Tapered)

Product Code:	CR509
Mouth Finish:	BVS 30 x 60
Diameter:	Shoulder 77.6mm / Base 72mm
Height:	329.5mm ± 2mm
Label Panel:	172.5mm
Punt Depth:	36mm
Weight:	695g
75cl Fill Point:	35mm
Pallet Load:	1,350
Layers:	6

Bordeaux RESOLUTE

Product Code:	CR5011
Mouth Finish:	BVS 30 x 60
Diameter:	75mm±1.5mm
Height:	329mm ± 2mm
Label Panel:	188mm
Punt Depth:	40mm
Weight:	695±25g
75cl Fill Point:	35mm
Pallet Load:	1,392
Layers:	6

NOTE A: CONTROLLED NECK & MOUTH REFER TO: DIMENSIONAL SPECIFICATIONS FOR BVS GLASS MOUTH FINISH – Norm: EN16293

75cl HOCK / FLUTE

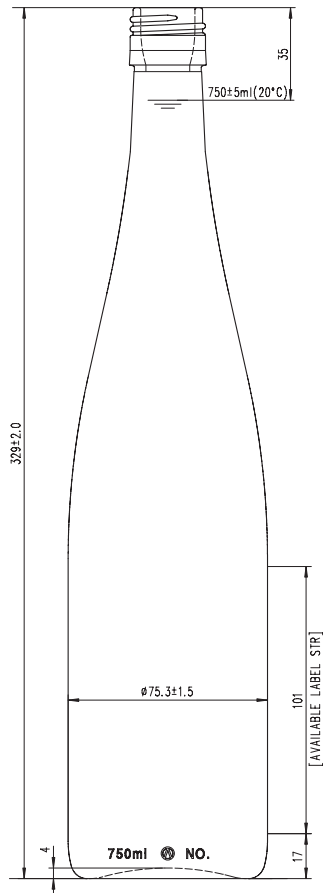

Flute PRIMO

Product Code:	CR302
Mouth Finish:	BVS 30 x 60
Diameter:	75.3mm ± 1.5mm
Height:	329mm ± 2mm
Label Panel:	92mm
Punt Depth:	4mm
Weight:	320g
75cl Fill Point:	35mm
Pallet Load:	1,392
Layers:	6

75cl SPARKLING

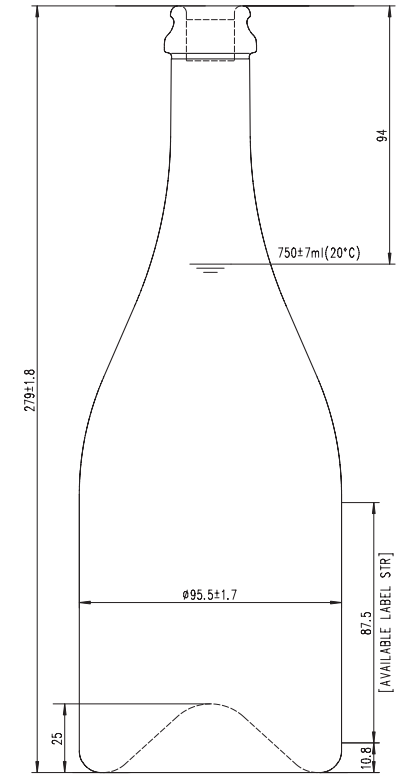
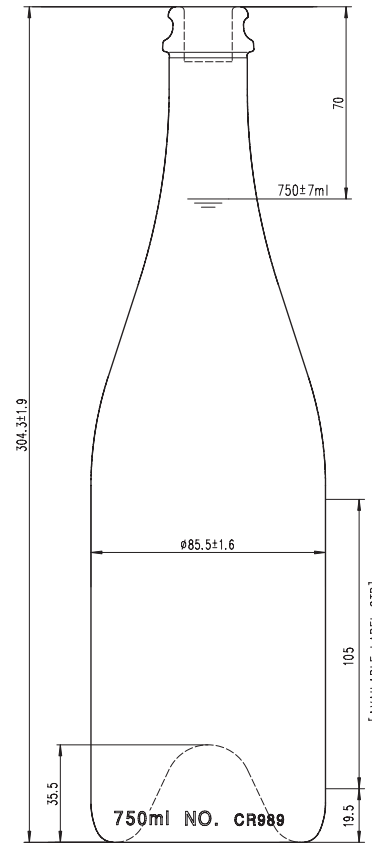
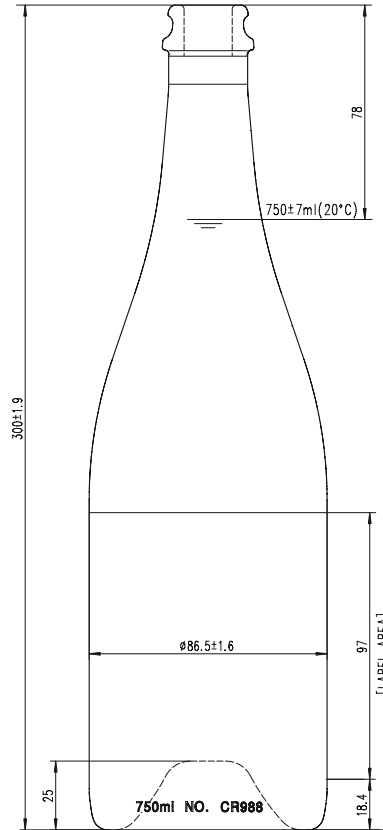
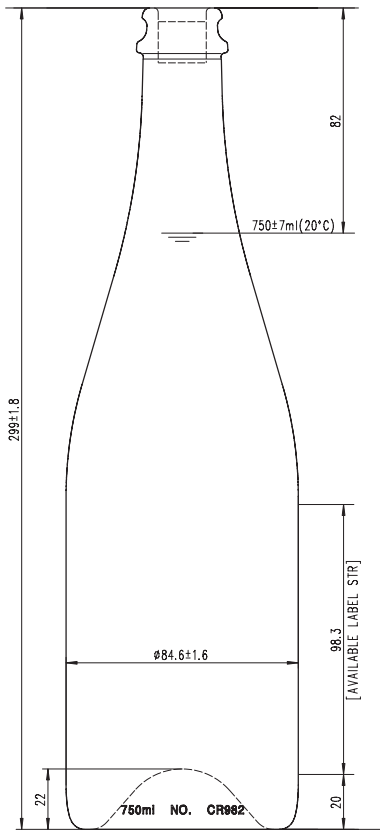

Sparkling CARBECO

Product Code:	CR982
Mouth Finish:	Crown 29mm
Diameter:	84.6mm ± 1.6mm
Height:	299mm ± 1.8mm
Label Panel:	98.3mm
Punt Depth:	22mm
Weight:	680g
75cl Fill Point:	82mm
Pallet Load:	1,225
Layers:	7

Sparkling BEAUMONT

Product Code:	CR988
Mouth Finish:	Crown 29mm
Diameter:	86.5mm ± 1.6mm
Height:	300mm ± 1.9mm
Label Panel:	97mm
Punt Depth:	25mm
Weight:	795g
75cl Fill Point:	78mm
Pallet Load:	1,169
Layers:	7

Sparkling GALLIVANT

Product Code:	CR989
Mouth Finish:	Crown 29mm
Diameter:	85.5mm ± 1.6mm
Height:	304.3mm ± 1.9mm
Label Panel:	105mm
Punt Depth:	35.5mm
Weight:	800g
75cl Fill Point:	70mm
Pallet Load:	1,229
Layers:	7

Sparkling BRUT

Product Code:	CR983
Mouth Finish:	Crown 29mm
Diameter:	95.5mm ± 1.7mm
Height:	279mm ± 1.8mm
Label Panel:	87.5mm
Punt Depth:	25mm
Weight:	880g
75cl Fill Point:	94mm
Pallet Load:	994
Layers:	7

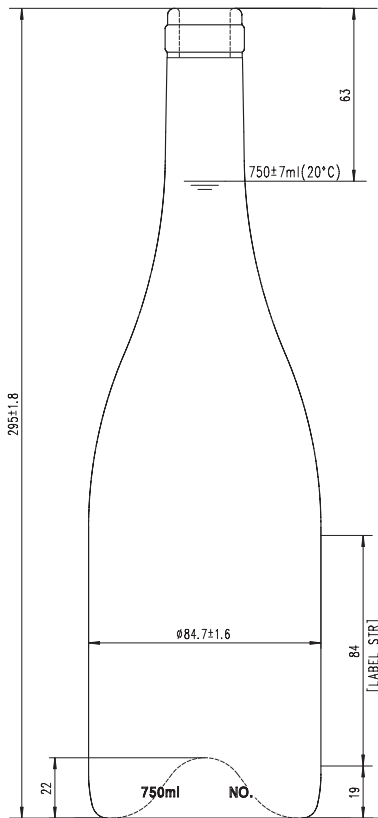

Burgundy LUCA V

Product Code:	CR418
Mouth Finish:	Cork 29
Diameter:	84.7mm ± 1.6mm
Height:	295mm ± 1.8mm
Label Panel:	84mm
Punt Depth:	22mm
Weight:	512g
75cl Fill Point:	63mm
Pallet Load:	1,229
Layers:	7

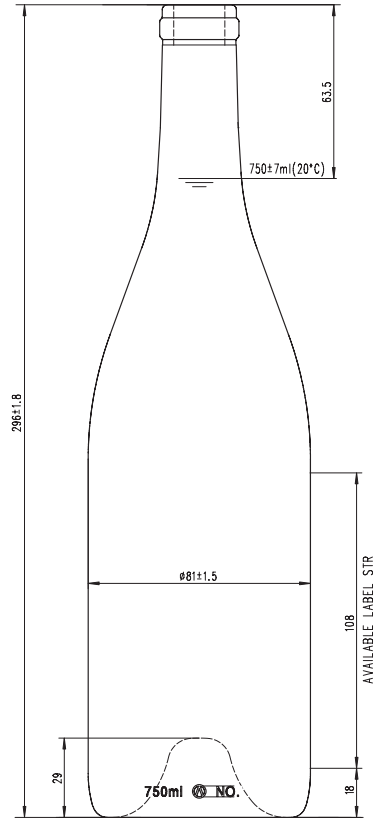

Burgundy TRADITIONAL C

Product Code:	CR416
Mouth Finish:	Cork 29
Diameter:	81mm ± 1.5mm
Height:	296mm ± 1.8mm
Label Panel:	108mm
Punt Depth:	29mm
Weight:	525g
75cl Fill Point:	63.5mm
Pallet Load:	1,372
Layers:	7

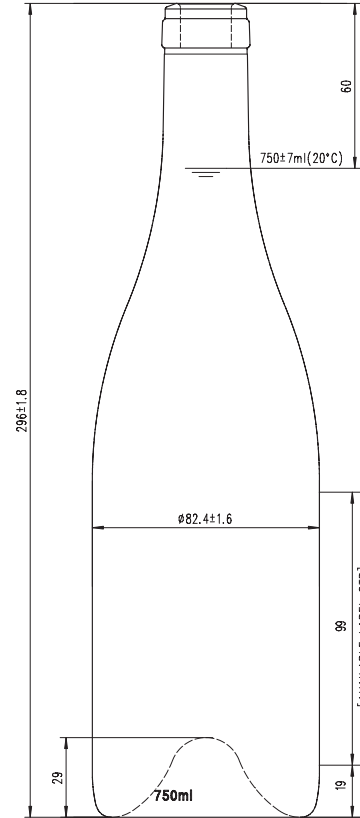

Burgundy DALI

Product Code:	CR427
Mouth Finish:	Cork 31.5 (Careé)
Diameter:	82.4mm ± 1.6mm
Height:	296mm ± 1.8mm
Label Panel:	99mm
Punt Depth:	29mm
Weight:	600g
75cl Fill Point:	60mm
Pallet Load:	1,372
Layers:	7

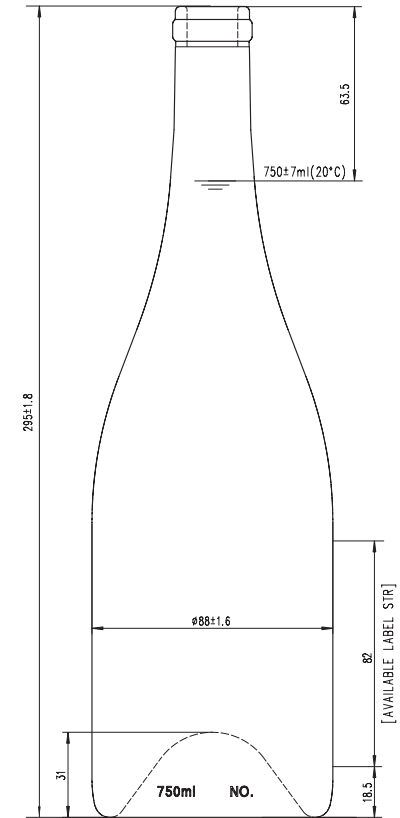

Burgundy LOLA

Product Code:	CR419
Mouth Finish:	Cork 29
Diameter:	88mm ± 1.6mm
Height:	295mm ± 1.8mm
Label Panel:	82mm
Punt Depth:	31mm
Weight:	640g
75cl Fill Point:	63.5mm
Pallet Load:	1,169
Layers:	7

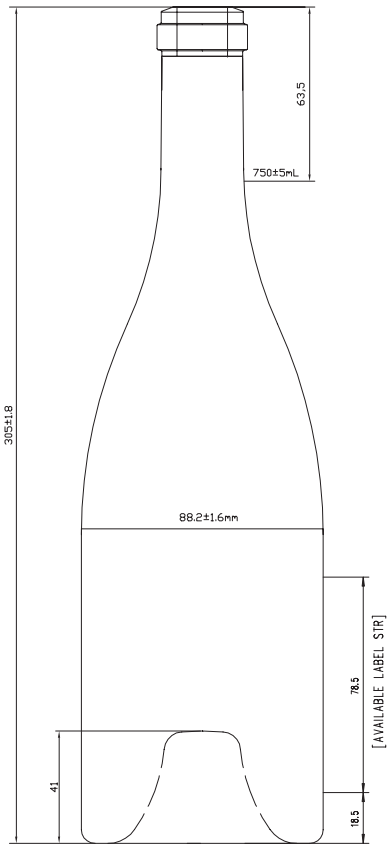

Burgundy MERCURE

Product Code:	CR446
Mouth Finish:	Cork 33 (Careé)
Diameter:	88.2mm ± 1.6mm
Height:	305mm ± 1.8mm
Label Panel:	78.5mm
Punt Depth:	41mm
Weight:	870g
75cl Fill Point:	63.5mm
Pallet Load:	1,176
Layers:	7

75cl BORDEAUX CORK¹

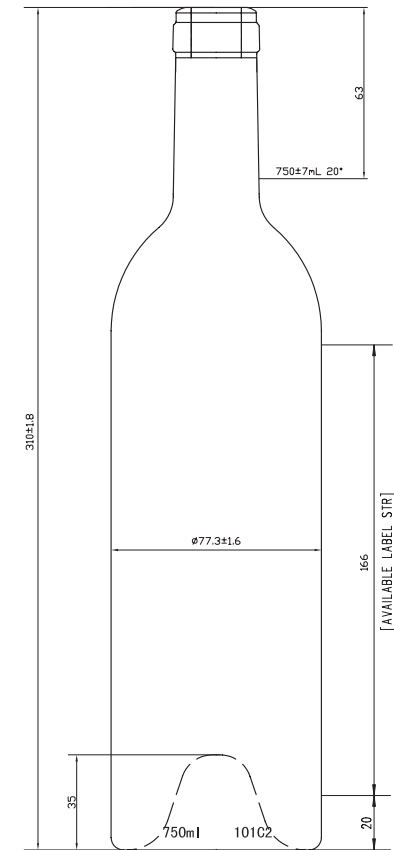
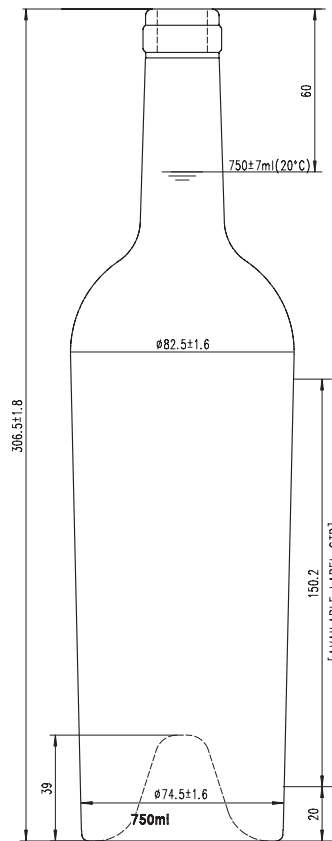
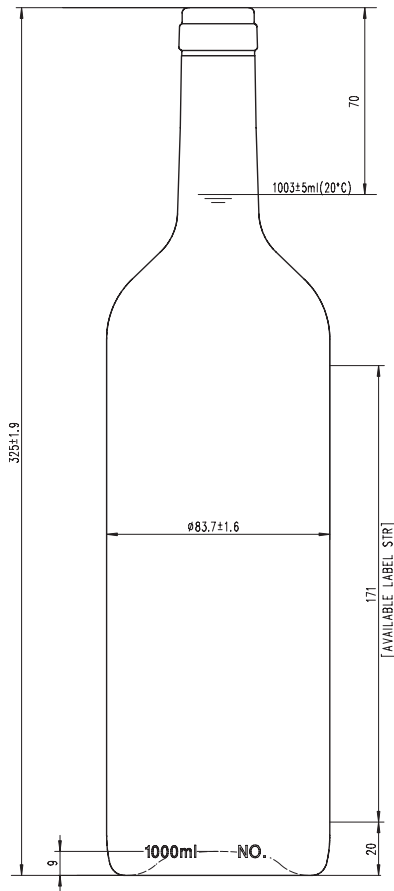
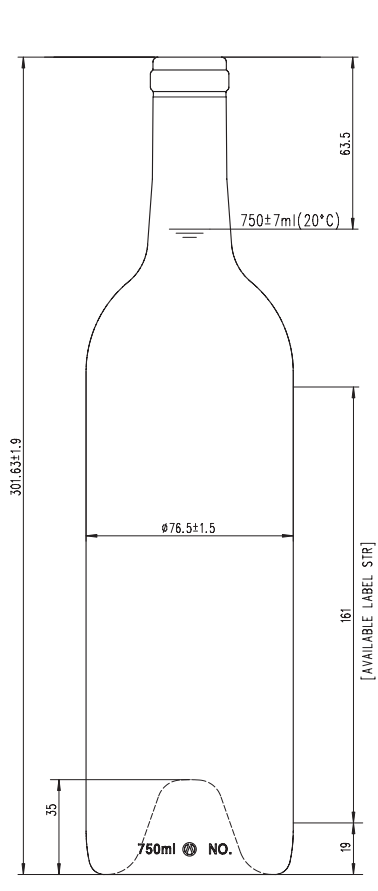

Bordeaux TRADITIONAL C

Product Code:	CR516
Mouth Finish:	Cork 29
Diameter:	76.5mm
Height:	301.6mm ± 2mm
Label Panel:	161mm
Punt Depth:	35mm
Weight:	540g
75cl Fill Point:	63.5mm
Pallet Load:	1,575
Layers:	7

Bordeaux FUTURA (1 Litre)

Product Code:	CR5125
Mouth Finish:	Cork 29
Diameter:	83.7mm
Height:	325mm ± 1.9mm
Label Panel:	171mm
Punt Depth:	9mm
Weight:	595g
75cl Fill Point:	70mm
Pallet Load:	1,080
Layers:	6

Bordeaux MEDOC (Tapered)

Product Code:	CR518
Mouth Finish:	Cork 29
Diameter:	Shoulder 82.5mm / Base 74.5mm
Height:	306.5mm ± 1.9mm
Label Panel:	150mm
Punt Depth:	39mm
Weight:	665g
75cl Fill Point:	60mm
Pallet Load:	1,372
Layers:	7

Bordeaux STRATUS

Product Code:	CR527
Mouth Finish:	Cork 31.5 (Careé)
Diameter:	77.3mm
Height:	310mm
Label Panel:	166mm
Punt Depth:	35mm
Weight:	695g
75cl Fill Point:	63mm
Pallet Load:	1,491
Layers:	7

75cl BORDEAUX CORK²

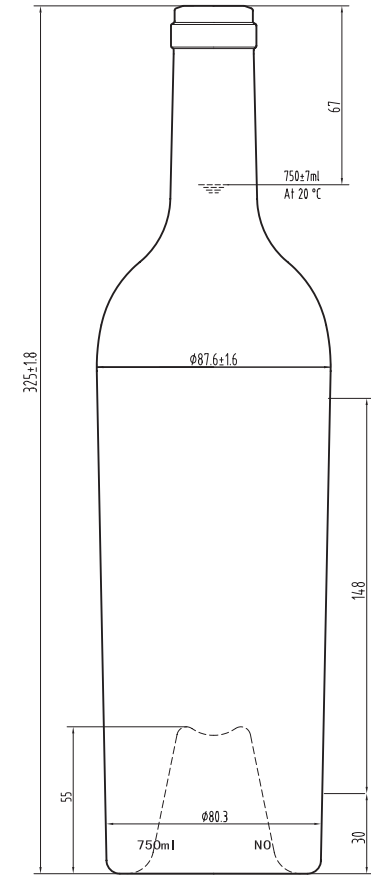
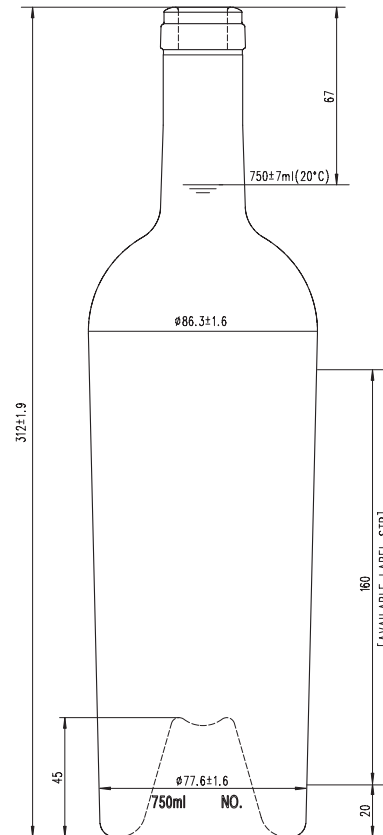
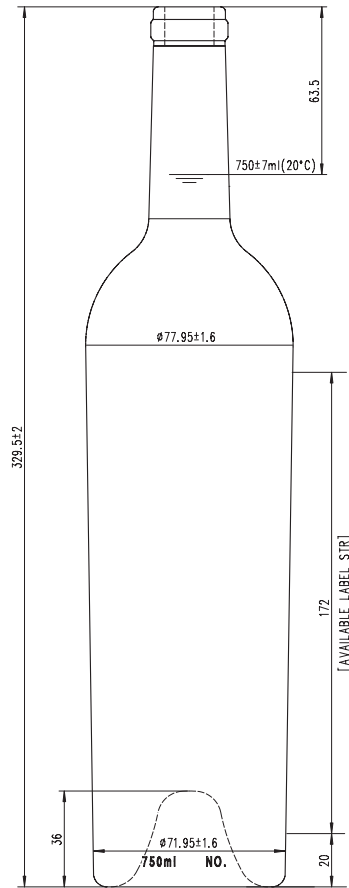

Bordeaux ELITE C (Tapered)

Product Code:	CR519
Mouth Finish:	Cork 29
Diameter:	Shoulder 77.95mm / Base 71.95mm
Height:	329.5mm ± 2mm
Label Panel:	172mm
Punt Depth:	36mm
Weight:	695g
75cl Fill Point:	63.5mm
Pallet Load:	1,350
Layers:	6

Bordeaux EMPEROR (Tapered)

Product Code:	CR529
Mouth Finish:	Cork 31.5 (Careé)
Diameter:	Shoulder 86.3mm / Base 77.6mm
Height:	312mm ± 1.9mm
Label Panel:	160mm
Punt Depth:	45mm
Weight:	990g
75cl Fill Point:	67mm
Pallet Load:	1,054
Layers:	6

Bordeaux REPENT (Tapered)

Product Code:	CR5312
Mouth Finish:	Cork 32 (Careé)
Diameter:	Shoulder 87.6mm / Base 80.3mm
Height:	325mm ± 1.8mm
Label Panel:	148mm
Punt Depth:	55mm
Weight:	1200g
75cl Fill Point:	67mm
Pallet Load:	858
Layers:	6



CHANDLER GLASS & PACKAGING

T: +64 9 448 1288 · E: info@chandler.co

PO Box 303-237, North Harbour,
Auckland 0751, New Zealand.

www.chandler.co

