

Burgundy BAMBINO (375ml)

PRODUCT CODE:	CR4037-1
MOUTH FINISH:	BVS 30 x 60
DIAMETER:	66mm \pm 1.3mm
HEIGHT:	242mm \pm 1.6mm
LABEL PANEL:	71mm (starts at 15mm)
PUNT DEPTH:	20mm
WEIGHT:	312g
75cl FILL POINT:	30mm

NEW ZEALAND

PALLET LOAD:	2,432
LAYERS:	8 (4 + 4)

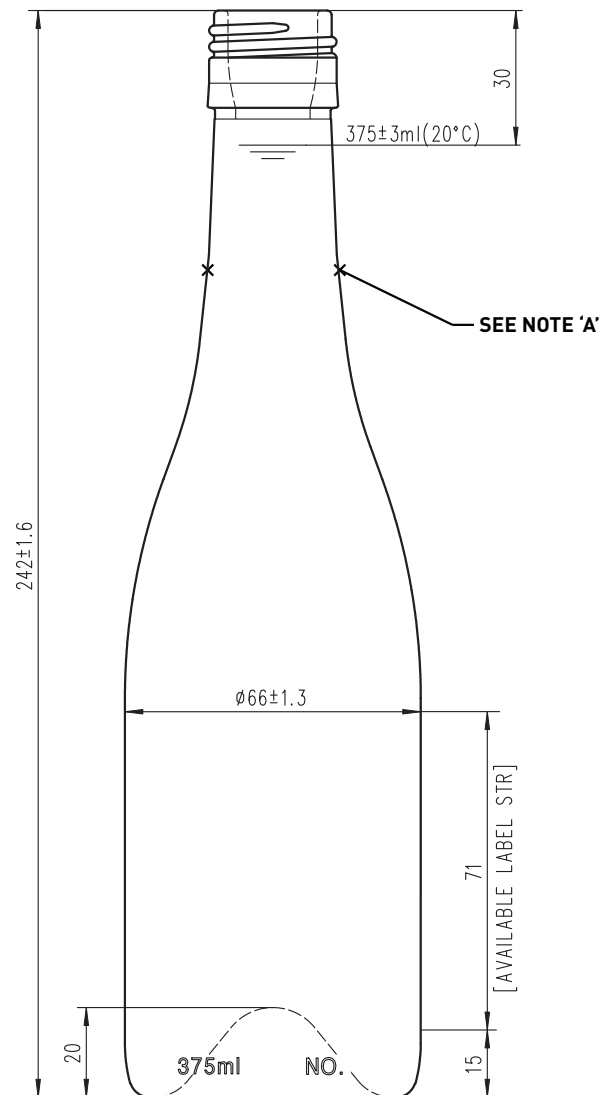

NOTE A: CONTROLLED NECK & MOUTH REFER TO DIMENSIONAL SPECIFICATIONS FOR BVS GLASS MOUTH FINISH Norm: EN16293



CHANDLER
GLASS & PACKAGING
www.chandler.co

New Zealand & Australia
PO Box 303-237, North Harbour,
Auckland 0751, New Zealand
E: info@chandler.co · T: +64 9 448 1288